



IceSLEET[®] G4 series

Quick Start Guide

Iceberg-Thermal.com

Box Content

A

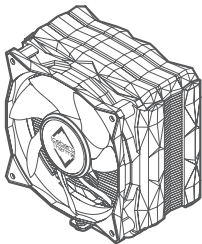

x1

B



x4

AMD

C



x4

D



x4

E

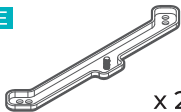

x2

INTEL

F

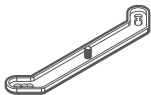

x2

G



x4

H

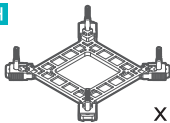

x1

AMD

AM4

B



E



C

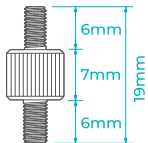

AM3(+) / AM2(+) / FM2(+) / FM1

B



E

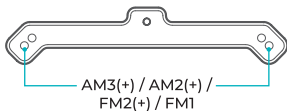

D

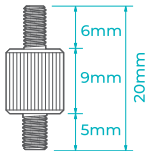

AMD

AM4

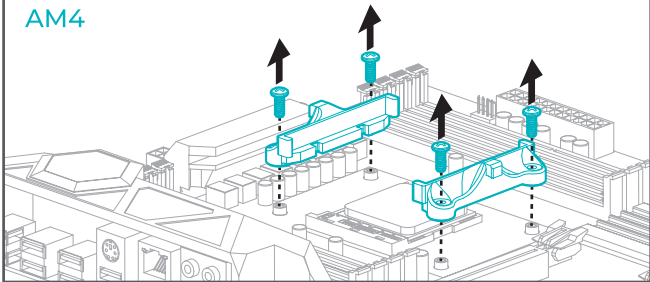

AM3(+) / AM2(+) / FM2(+) / FM1

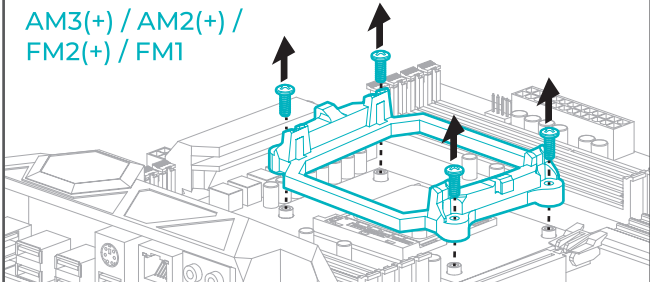

AMD

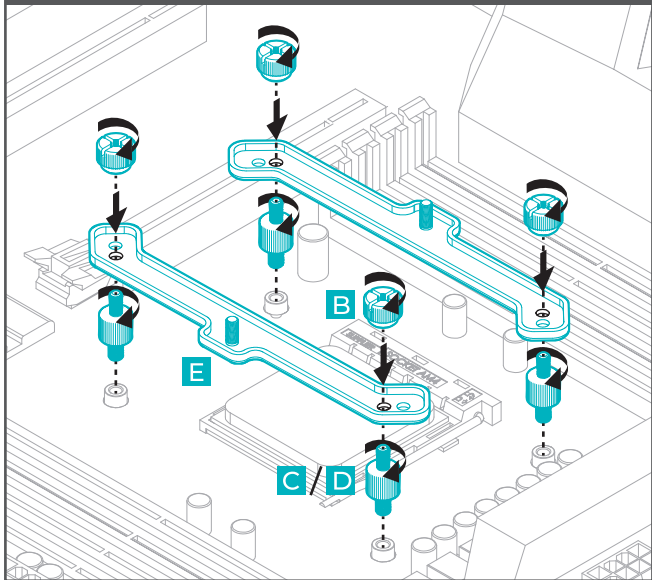

INTEL

B



F

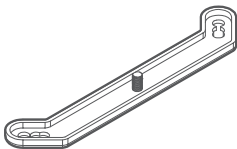

G



H

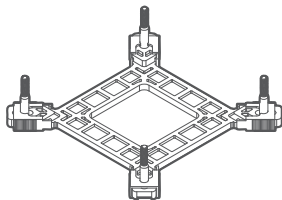

INTEL

F

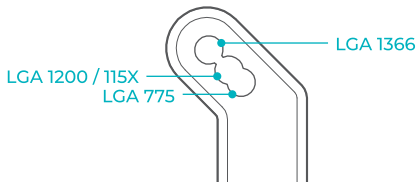

H

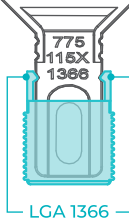
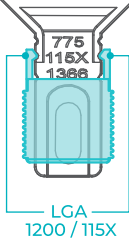
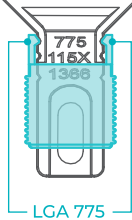

INTEL

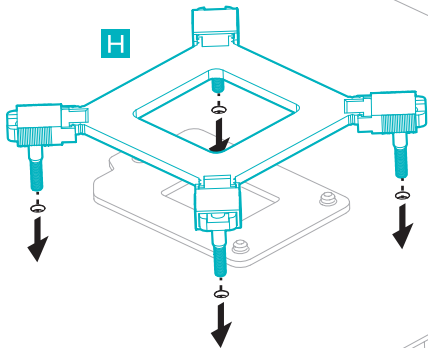

INTEL

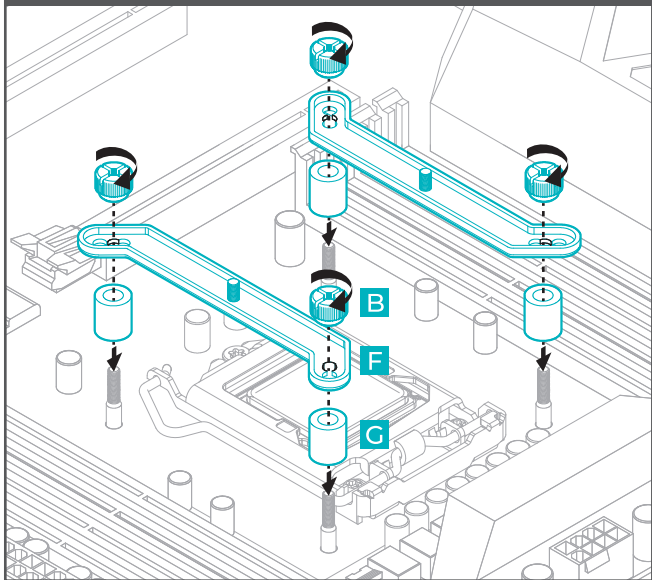

Step 1

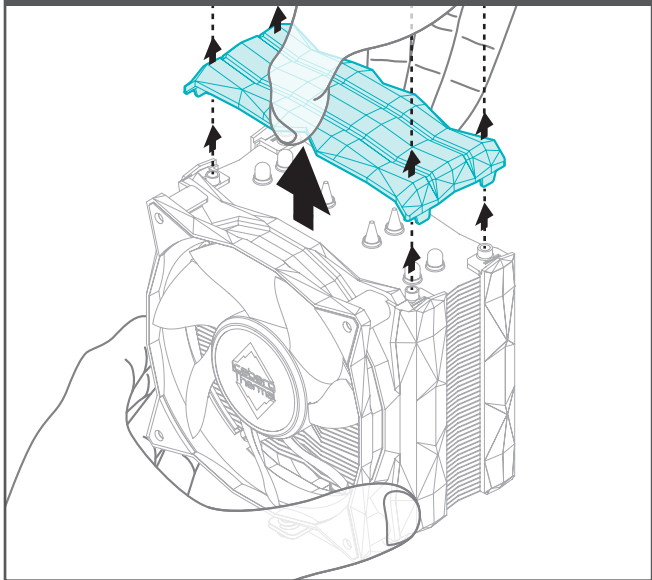

Step 2

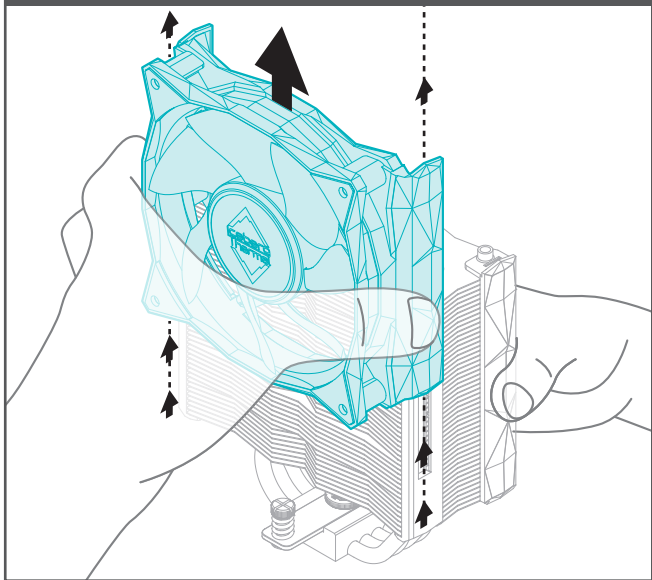

Step 3

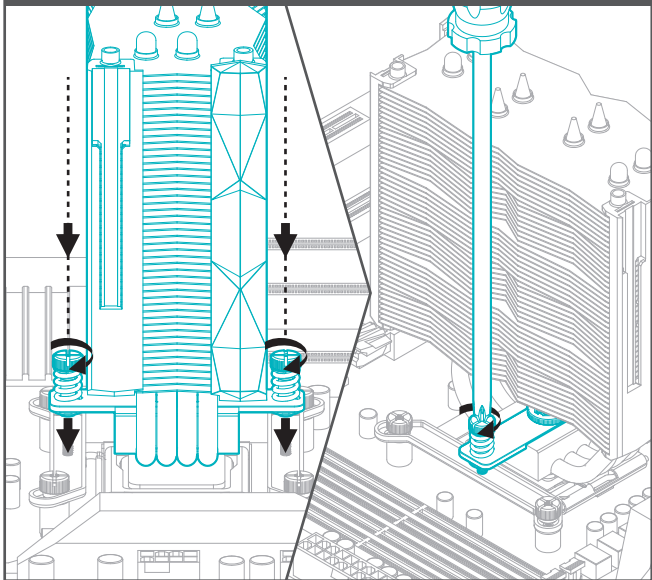

Step 4

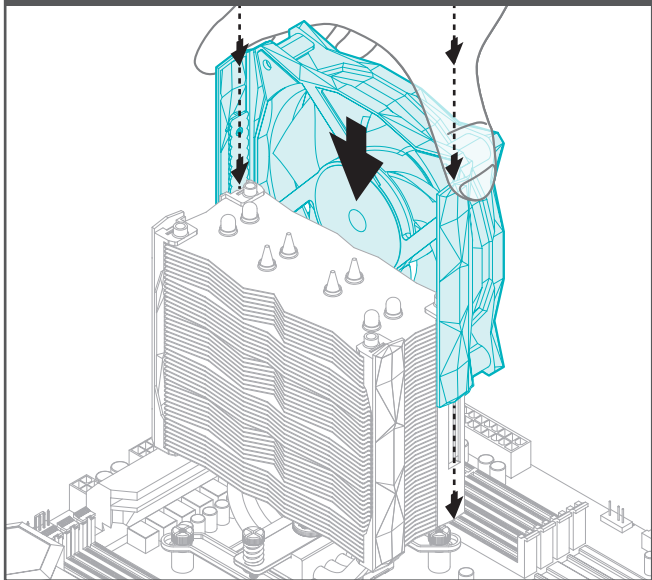

Step 5

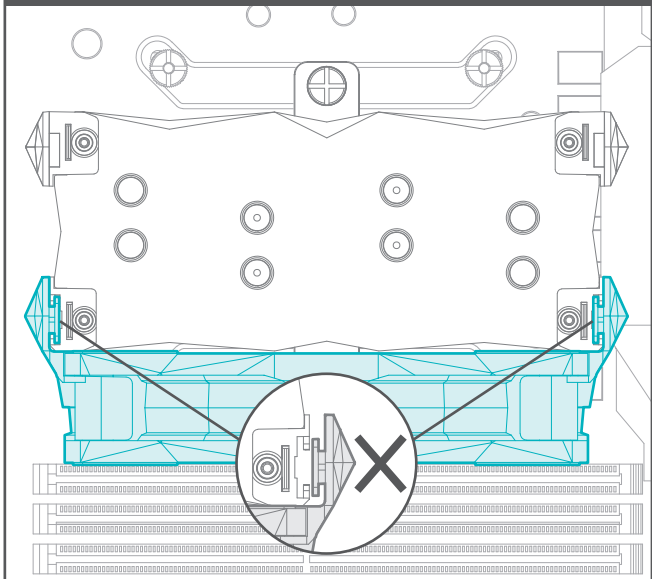

Step 6

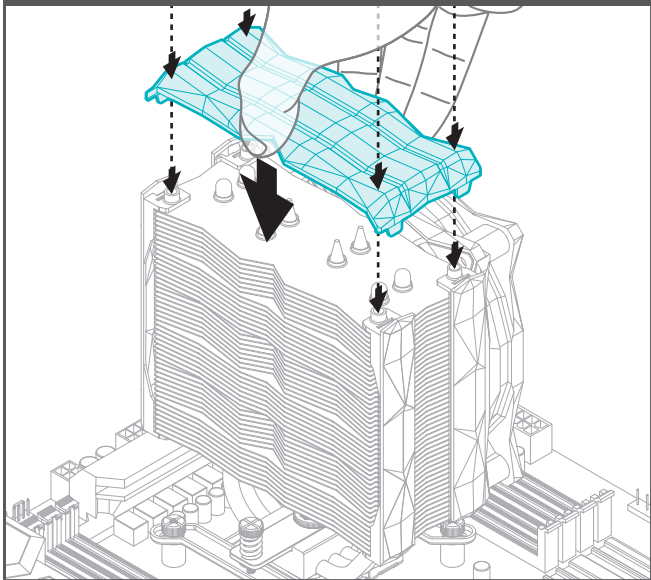

Step 7

