



IceSLEET® X7 Dual

Quick Start Guide

Iceberg-Thermal.com

Box Content

A



x1

B



x4

C



x1

D

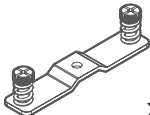

x1

E

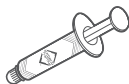

x1

F

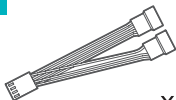

x1

AMD

G



x4

H



x4

I

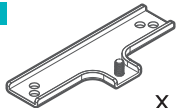

x2

INTEL

J



x4

K

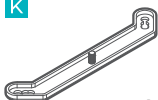

x2

L



x4

M

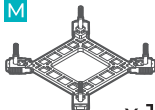

x1

AMD

AM4

B



I

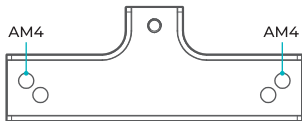

G

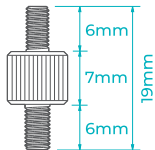

AM3(+) / AM2(+) / FM2(+) / FM1

B



I

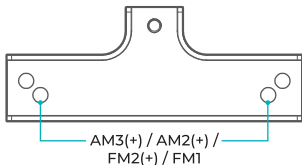

H

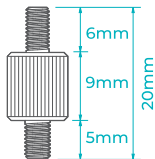

AMD

AM4

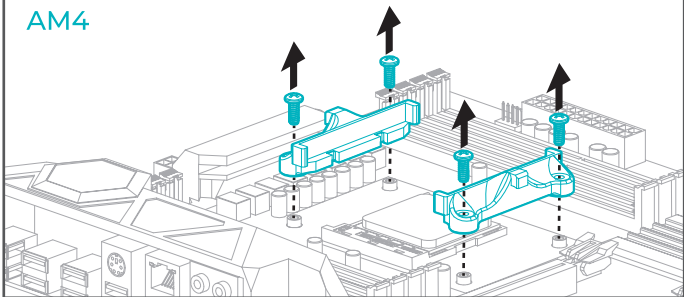

AM3(+) / AM2(+) FM2(+) / FM1

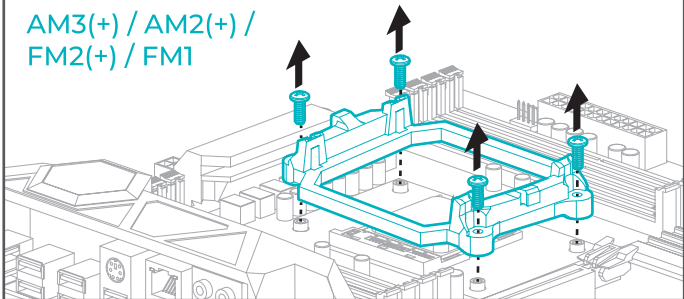

AMD

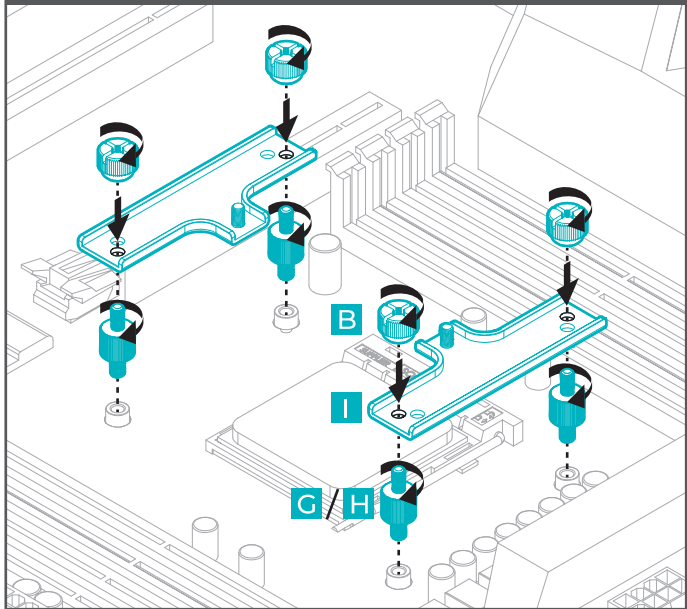

INTEL

LGA 2066 / 2011-0 / 2011-3 (Square ILM)

B



K

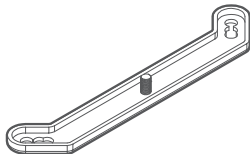

J

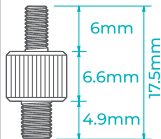

LGA 1200 / 115X / 1366 / 775

B



K

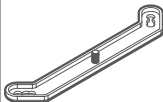

L



M

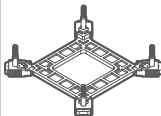

INTEL

K

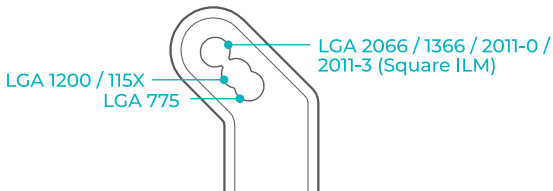

M

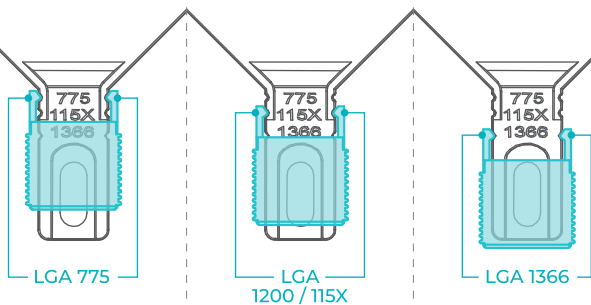

INTEL

LGA 2066 / 2011-0 / 2011-3 (Square ILM)

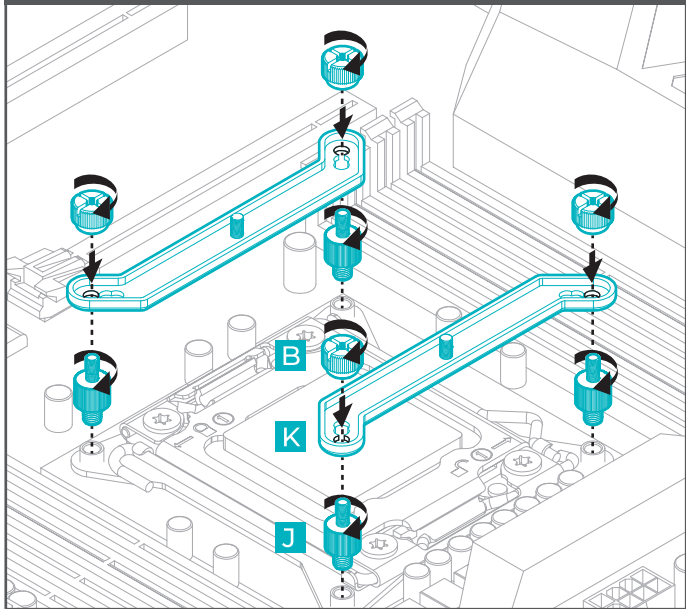

INTEL

LGA 1200 / 115X / 1366 / 775

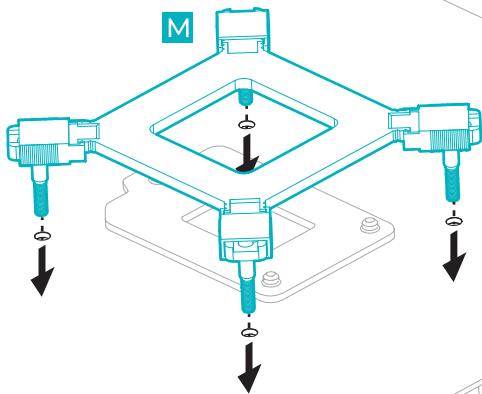

INTEL

LGA 1200 / 115X / 1366 / 775

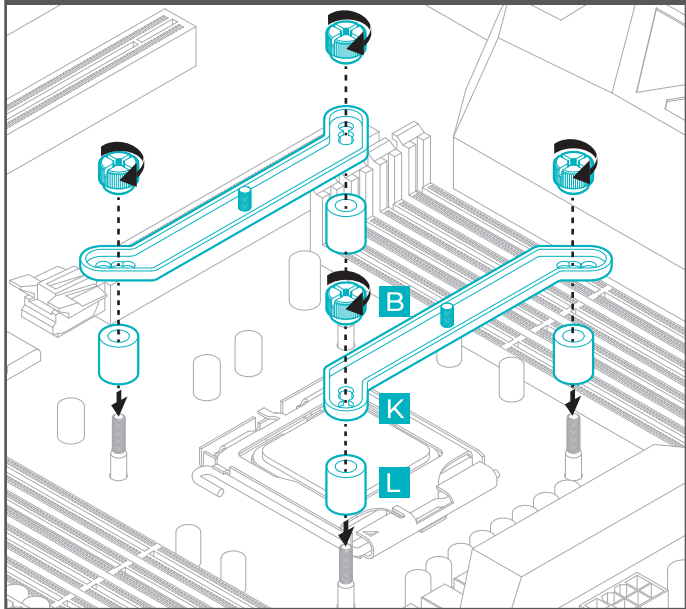

Step 1

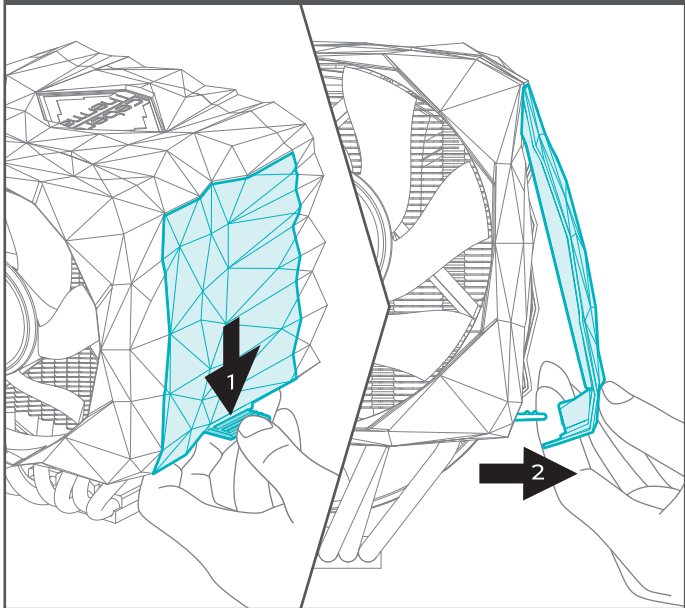

Step 2

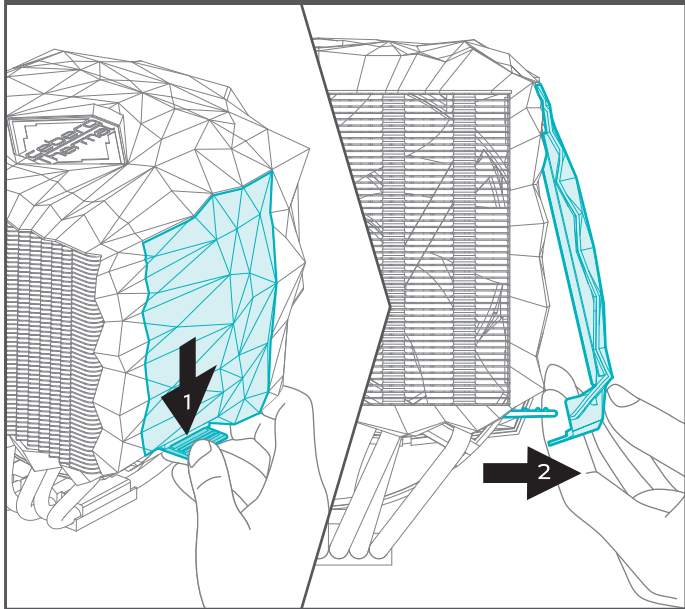

Step 3

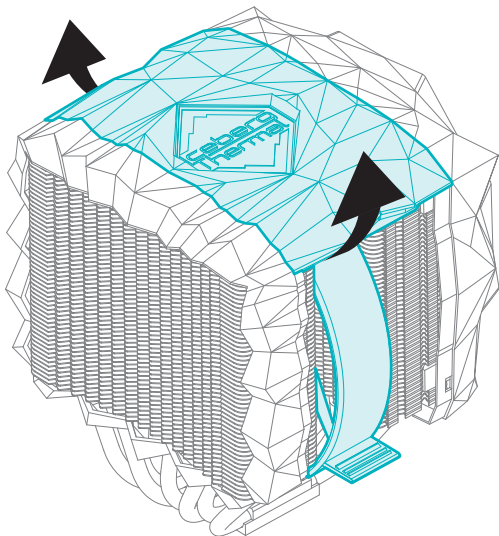

Step 4

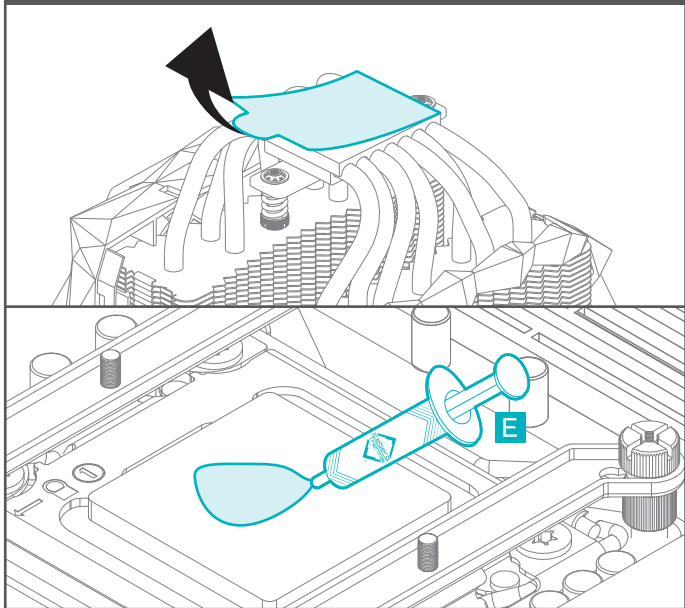

Step 5

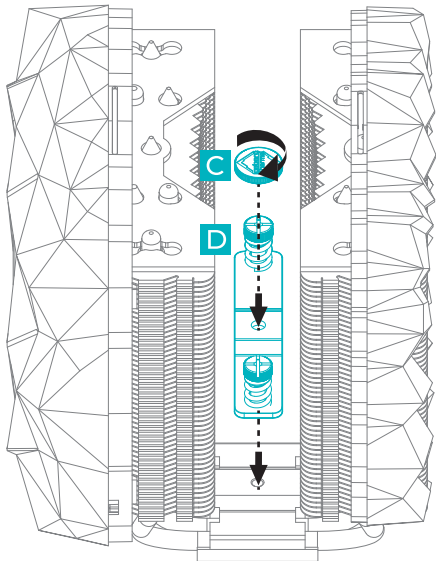

Step 6

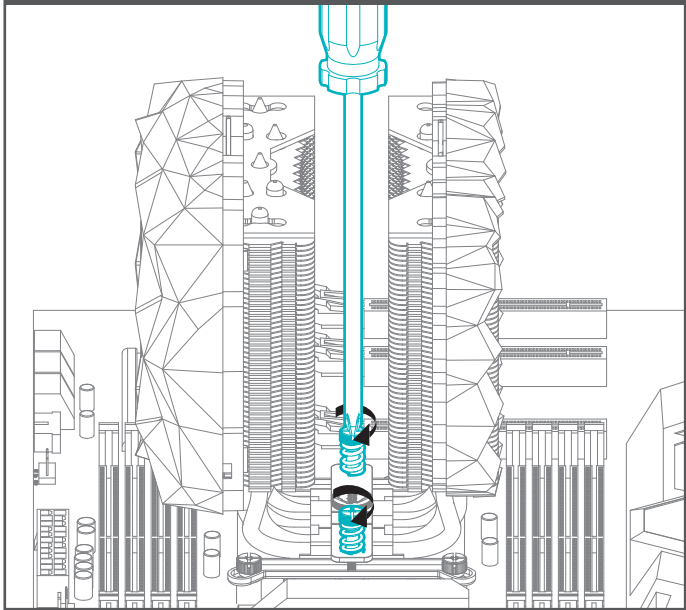

Step 7

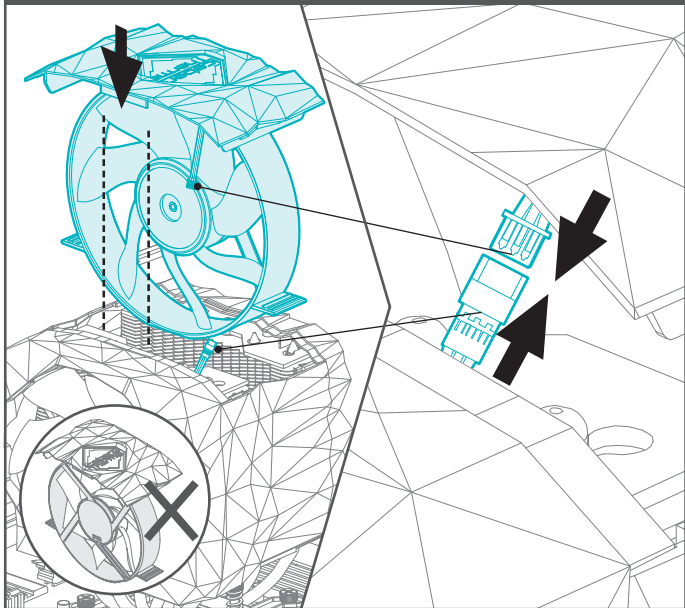

Step 8

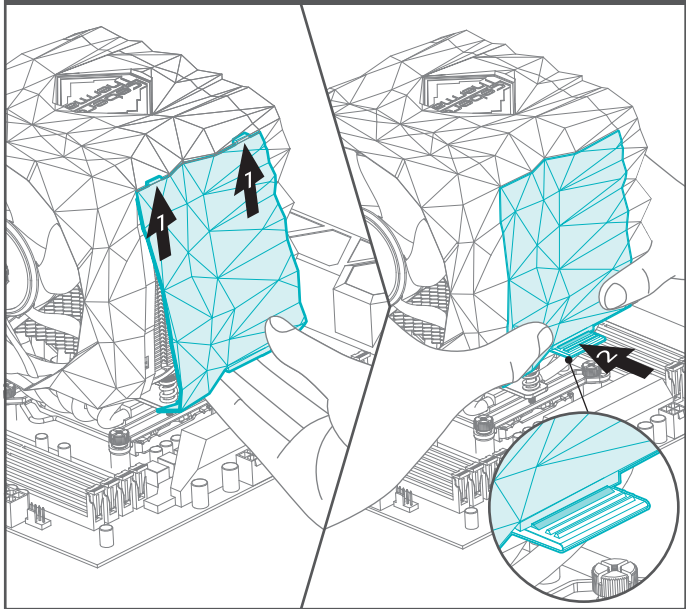

Step 9

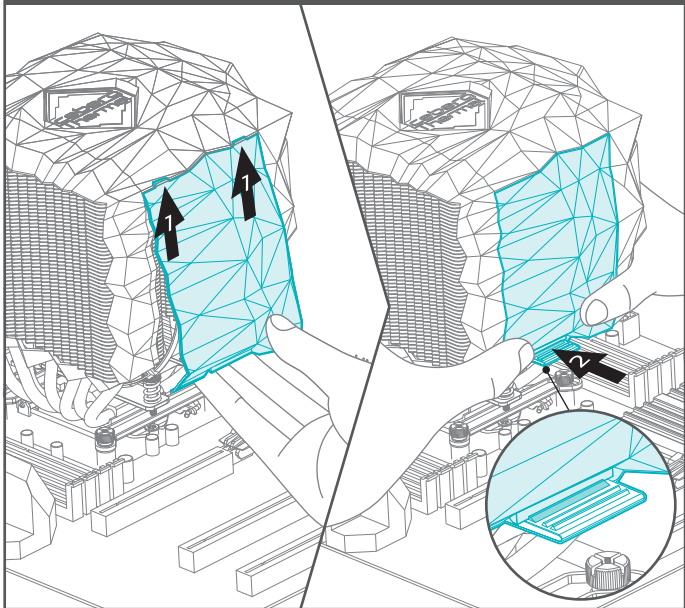

Step 10

